



2008

2009

Entry Island School

Year Book & Community Cook Book



Message from the Principal

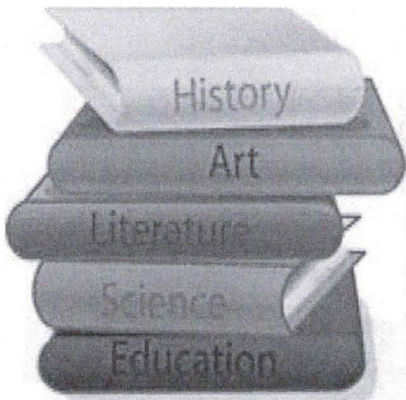

As administrator and teacher, I have had the great opportunity of not only teaching these extraordinary students, but making sure they get the best education possible.

The Entry Island students are all unique. Their little minds are always working and as one parent told me, each day a child learns something new. Well if one were to learn something 365 days a year, they are truly a genius. I am very proud and fortunate to have participated, even only if very minute.

The 2008-2009 school year, has been a very busy, and rewarding year. I had the great pleasure of being their teacher, mentor, chief cook and bottle washer, part time chauffeur, nurse and advisor. Although we are a small school, population wise, we are BIG in every other way. The Terry Fox Cancer Foundation, track and field, Geordie Productions, Christmas Concert, Halloween Party, are just some of the many activities Entry Island School has been involved with.

Once again, I would like to state that I am very proud of each of my students. It has been a great year and I have enjoyed teaching all of you. Braiden, ready with a daily story to tell me; Zachary smiling and adding his two cents worth to the story; Leo with his daily hug and ready smile; Logan's twinkly eyes and not so quiet voice anymore; Ethan who has lots of love to give us, and Hayley who always knows me best and tells me so. Marcus with his mercurial smile when he is telling us something; Veronica with her laughter after I have just said something out of context, and last but not least, Britty our story teller, author, thinker, playwright, busy bee who is always giving us new and never-ending ideas. Britty never stop dreaming each day, because I know that someday you will dream big and that dream may come true.

Continue the great work students!! Congratulations one and all from Grade Pre-K up to Grade 6!!

As for our one and only Grade 8 Graduate Student-- Stacey Dickson-- Congratulations & Good Luck!! I know that it has been difficult at times being alone, however, you have made our time in school a lot less hectic and a great deal more pleasant. As the oldest student, all the younger kids not only count on you but look up to you and love you too, Stacey. Not only do they respect you, but I too have also enjoyed each and every minute with you and my only hope is that you dream big and set out to accomplish that big dream!!

Judy Aitkens

Welcome to Pre-k

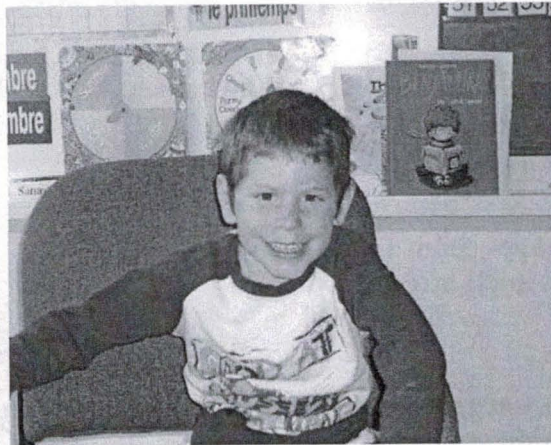

Ethan Aitkens

1. What do you want to be when you grow up? A worker
2. What is your favourite cartoon? Batman
3. What is your favourite animal? A cow
4. Who do you think is the strongest person on Entry Island? Jeremy
5. What do you like to do (or play)? Swing

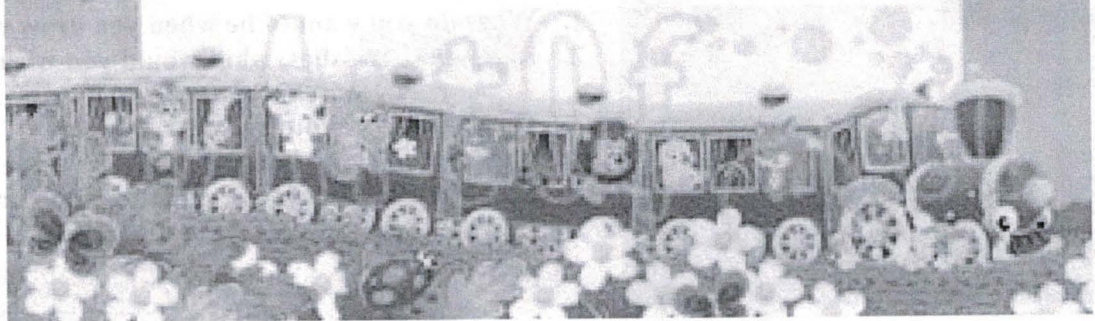

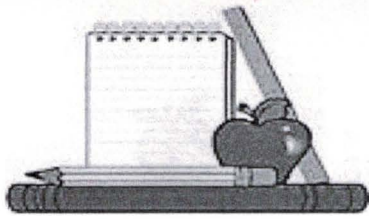

Welcome to Grade 1



Leo Brymer

1. **What do you want to be when you grow up?** Cop
2. **If you had 2 wishes, what would you wish for?** Million dollars & a dirt bike.
3. **What is your favourite sport?** Soccer
4. **Name 1 thing you hate to do?** Get hurt
5. **Who do you think is the richest person on Entry Island?** Grampy Lindberg

1. **What do you want to be when you grow up?** Policeman
2. **If you had 2 wishes, what would you wish for?** Monster truck & Backhoe
3. **What is your favourite sport?** Basketball
4. **Name 1 thing you hate to do?** Play soccer
5. **Who do you think is the richest person on Entry Island?** Wayne

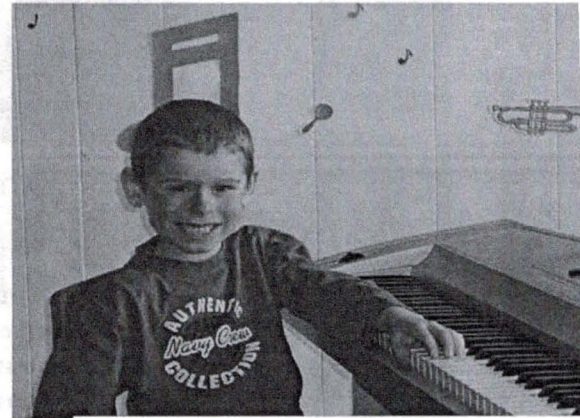

Zachary Aitkens

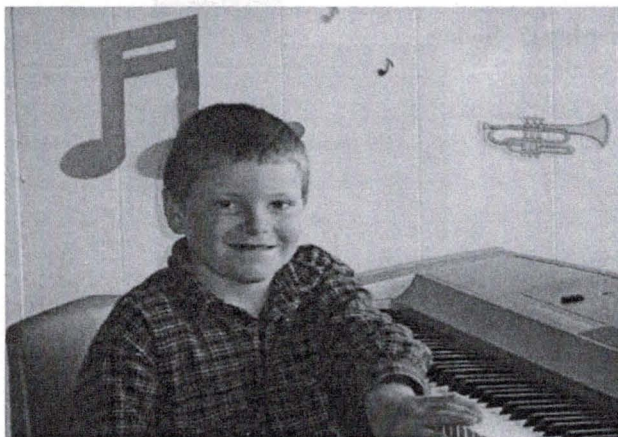

Logan Chenell

1. **What do you want to be when you grow up?** Policeman
2. **If you had 2 wishes, what would you wish for?** 4-wheeler & Monster truck
3. **What is your favourite sport?** Hockey
4. **Name 1 thing you hate to do?** Running
5. **Who do you think is the richest person on Entry Island?** Uncle Donnie



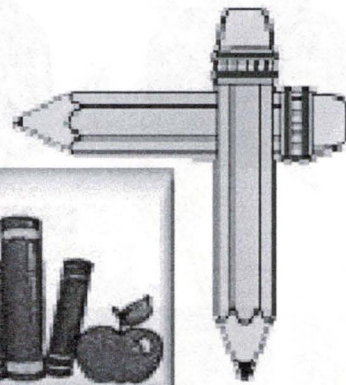
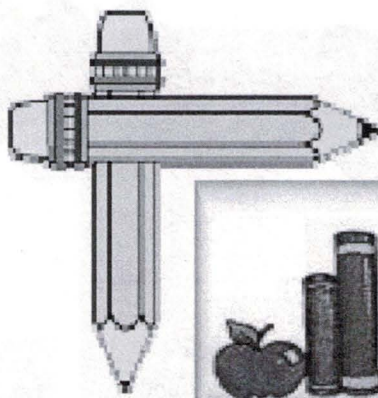

Welcome
Grade 2

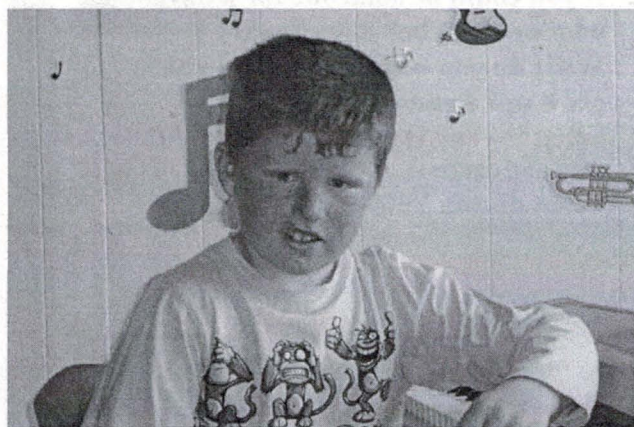

Braiden Clarke

1. **What do you want to be when you grow up?** Fisherman
2. **If you had 2 wishes, what would you wish for?** Tractor & Backhoe
3. **What is your favourite sport?** Hockey
4. **Name 1 thing you hate to do?** Tying my shoes
5. **Who do you think is the richest person on Entry Island?** Steven

1. **What do you want to be when you grow up?** Teacher
2. **If you had 2 wishes, what would you wish for?** A 4-wheeler & for me and Maddie to share a room with bunk beds in it.
3. **What is your favourite sport?** Dodge Ball
4. **Name 1 thing you hate to do?** Getting up in the morning
5. **Who do you think is the richest person on Entry Island?** Mom



Hayley Dickson

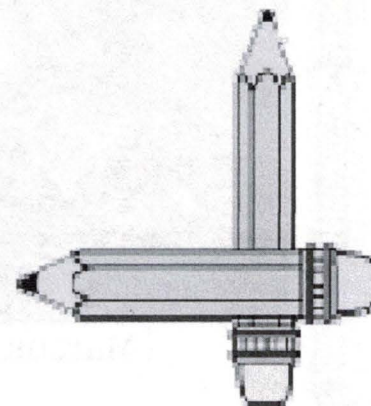
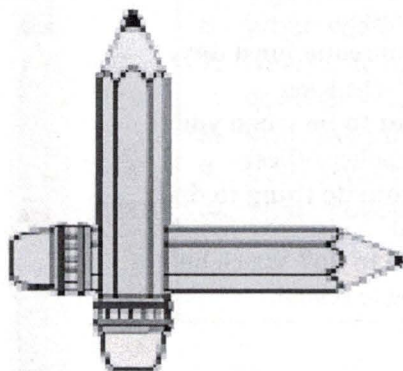

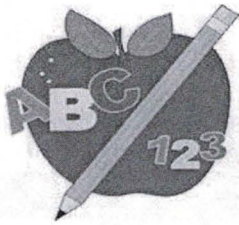

Grade 4, 5, & 6



Brittany Dickson

1. **What would you do if you won a million dollars?** Travel to Disney Land; buy nice clothes & a mansion for the whole family.
2. **If you could be someone for a day, who would it be?** Miley Cyrus
3. **What do you want to be when you grow up?** Beauty Salon Person
4. **What is your favourite thing to do?** Sing and dance
5. **What do you hate to do?** Perform in front of a lot of people by myself

1. **What would you do if you won a million dollars?** Go on a trip to Florida
2. **If you could be someone for a day, who would it be?** Hannah Montana
3. **What do you want to be when you grow up?** Teacher
4. **What is your favourite thing to do?** Hang out with friends
5. **What do you hate to do?** Washing dishes



Veronica Chenell



Marcus Brymer

1. **What would you do if you won a million dollars?** Buy clothes, toys, red convertible car, roller blades, skate board, hockey rink & a mansion.
2. **If you could be someone for a day, who would it be?** The King
3. **What do you want to be when you grow up?** Chef or police officer
4. **What is your favourite thing to do?** Play soccer baseball
5. **What do you hate to do?** Watch little brother Leo & going to school.



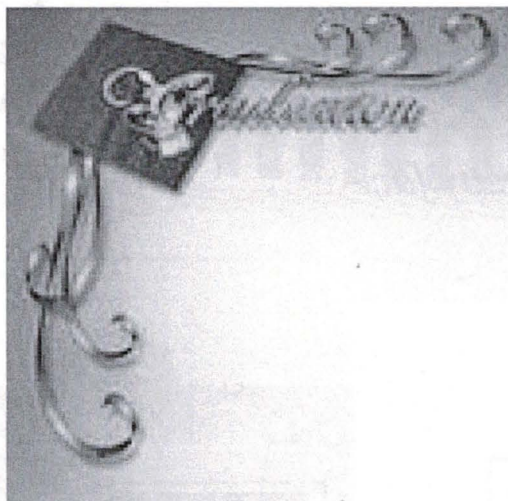

Stacey Michelle Dickson – Grade 8

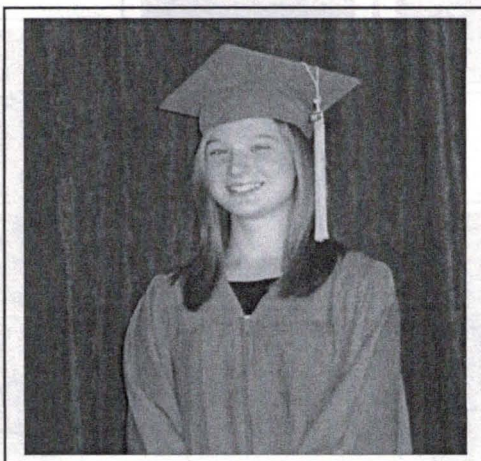

1. Birthday – March 22, 1995
2. Nick name – Stacey, Mish or Michelle
3. Hobbies – Computer, Listening to music & Being with friends
4. Future ambition - Teacher
5. If you had one wish, what would it be – Visit the Bahamas
6. What was your favourite elementary school grade – Grade 6 in Fatima
7. Name one thing you are good at, and one thing you think you're not good at – Good at swimming & not at Volleyball
8. Your favourite actor/singer – Miley Cyrus
9. Your favourite food – Spaghetti & homemade meat sauce
10. Your Favourite Color – Baby blue & purple



She's more than just a pretty face...

She's a dirt bike driver



She's a singer



She's a wall climber



She's a beauty queen

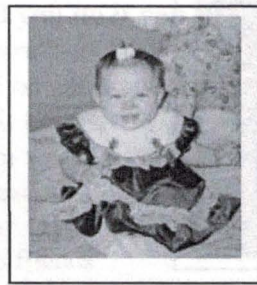

She's a weight lifter



She's a horse back rider



She's a model



She's a ballerina

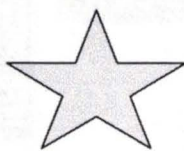

Swimming Courses

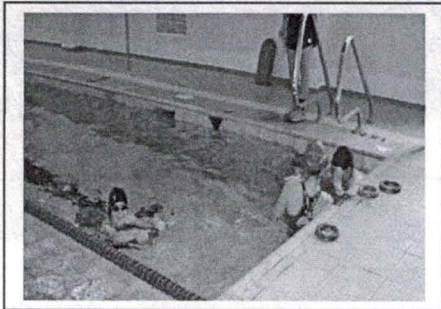
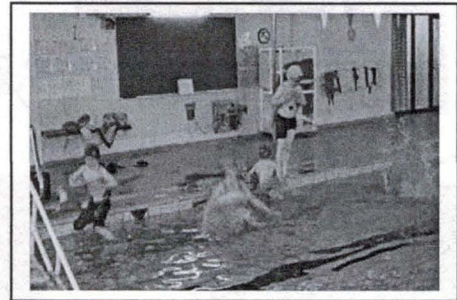
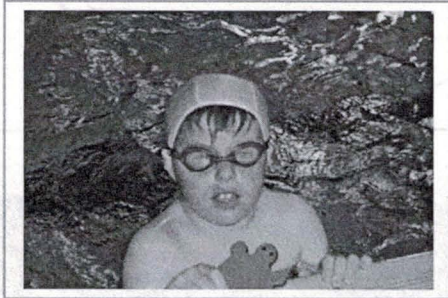

You never miss the water
till the well runs dry!!!!



Fun Times!!!



Project Love Activities

WEDNESDAY



Backwards Day

Pyjama Day !!!!!!!!

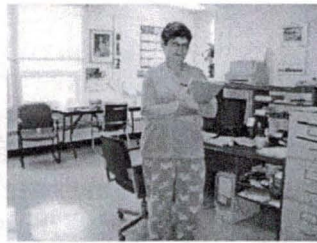

Project Love is an organization which helps third world countries in need of help. Our students and teachers raise funds from September up until February by dedicating every Wednesday as "Loonie Day", when everyone donates a loonie to this cause. Throughout the year there are a variety of activities held on certain Wednesdays, for example, Crazy Hat Day, Jean Day, Pyjama Day, Wacky Hair Day and even Backwards Day. With the monies raised Project Love kits are purchased. These kits contain school supplies such as, a pencil, eraser, notebook and ruler. The kits are then packed into boxes by the students and shipped to our partners overseas where they are distributed to students in schools and community libraries. This school year our school raised \$142.00 and created 60 kits plus donated the postage. Congrats Students!!!

ACTIVITIES & EVENTS

Track & Field

On September 19, 2008, Stacey Dickson (grade 8), Veronica Chenell (grade 5) and Brittany Dickson (grade 4) flew to Gaspé with their chaperone, Candace Aitkens, to participate in the annual Eastern Shores School Board Track and Field Event. Entry Island School was proudly represented when Stacey flew over the finish line in first place during the 400 meter run in the Bantam girl's category. She also came in fourth place in the 100 meter run. Veronica and Brittany also did their best in their events. Great job girls!!!

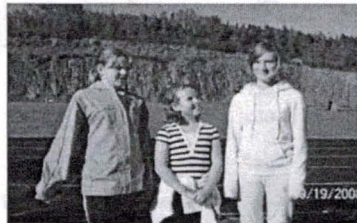
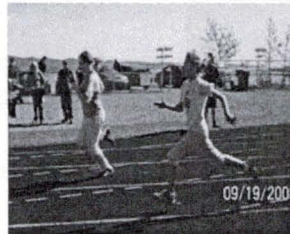

Geordie Production

In October, the Entry Island students were invited to the Grosse Isle School to watch the play, "The Lion, The Witch and The Wardrobe", which was acted out by young actors from the Geordie Production group. This was made possible through the financial assistance of C.A.M.I and the ESSB. Lunch was also provided for us by the staff and board members of C.A.M.I. This event has been going on annually for over a decade and is always enjoyed by the children.

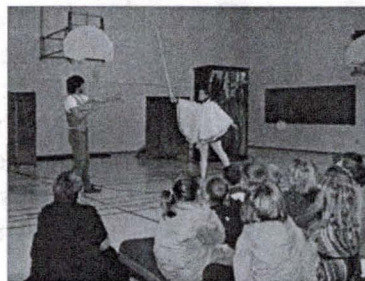

Remembrance Day

Again this year on November 11, 2008 there was a Remembrance Day service held at All Saints' Memorial Church with the students and CAMI employees, Thelma Feltmate and Candace Aitkens. Every veteran from Entry Island was acknowledged when their names were read during the service along with the reciting of poems, prayers and stories. Following the service, everyone was invited to the Entry Island Historical Museum to view the war memorabilia that is on display along with the many pictures of the veterans.

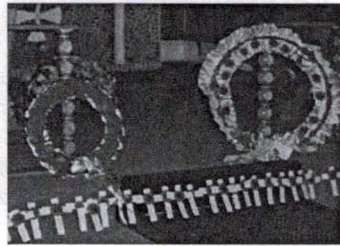

Science Fair

On April 23, 2009, the Entry Island School held their annual science fair. Each student had two experiments to perform. This was an educational as well as a fun activity for the children and parents alike.

We would like to take this opportunity to thank the parents for attending and congratulate the students on a job well done!!



"I wonder what is so funny??"

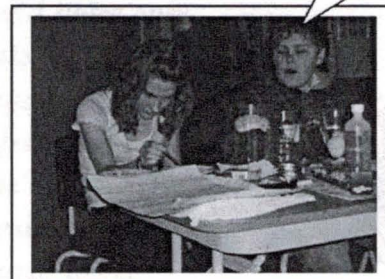

"That's it Stace, you're almost got it"



"Wow that was awesome!"

Smiling from year to year is real happiness!

Island Clean-up

Every spring the students, staff and a few community members get together and clean up the island. The Municipalité des Iles gives a certain amount of money to the school children for their participation. When everyone was finished, a lunch was served at the school. We would like to take this opportunity to thank those community members who participated in helping us keep the island clean. Your help was much appreciated.

One Volunteer is
Better than ten
Forced men...



Healthy Breakfast

Since March is "Nutrition month", C.A.M.I.'s Diabetes Awareness & Prevention Coordinator, Colleen Hunt, visited Entry Island School to help organize and prepare a healthy breakfast. The family members of the students were invited. Sherry Welsh, our school nurse, also attended. She explained about proper nutrition and healthy eating habits. There was a variety of foods from all four food groups. Some of the children and adults had an opportunity to try foods that they have never eaten before.



♥♥ A fool says, "I can't" but a Wiseman says, "I'll try" ♥♥



Reading

It does a mind good ♥

Book Fest Week

To end our Book Fest week, on Friday, April 24, the elementary students went to Grosse Ile School for the day and personally met a well known author / illustrator of children's books. Her name was Marie Louise Gay from Montréal. It was a wonderful presentation. She explained what she does and how she prepares to write and illustrate a new book. Two of our students, Leo Brymer and Logan Chenell were lucky enough to receive an autographed copy of one of her books in a participation draw. It was a real pleasure to take part in this activity. Thank you to Grosse Ile School for inviting us.

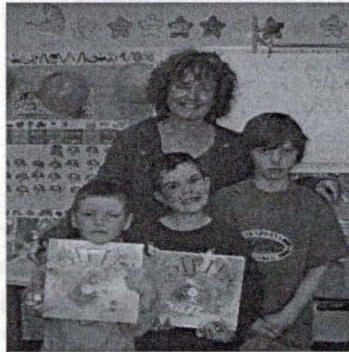

*I've traveled the world twice over,
Met the famous; saints and sinners,
Poets and artists, kings and queens,
Old stars and hopeful beginners,
I've been where no-one's been before,
Learned secrets from writers and cooks
All with one library ticket
To the wonderful world of books.*

~ Anonymous ~

!!!! HOLIDAYS !!!!

Halloween



Christmas

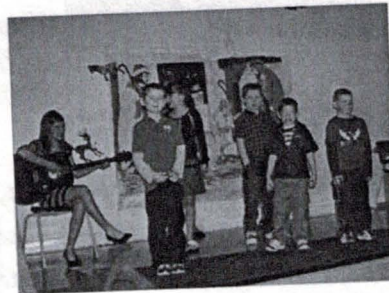

Valentine's Day



Big accomplishments for such a small school

Throughout the school year our students raise money for various organizations. Even though there are only ten students, they always seem to do really well and get involved. This is a great way for the children to learn how to become community volunteers and help others less fortunate than themselves.

❖ The Terry Fox Run

- ✦ This is an annual event every September. The students are told about this great hero and why it is important to help fundraise for this cause. This year our students raised \$353.00 for the Terry Fox Cancer Society. The school staff are very proud of their students!!

❖ MS Read-a-Thon

- ✦ This year the students also participated in the MS Read-a-Thon. In fact, they enjoyed this very much, as most of the students love to read. We took the opportunity to use this 14 day event also for our yearly book fest. The students who took part in the read-a-thon were Braiden Clarke, Marcus Brymer, Leo Brymer, Zachary Aitkens, Stacey Dickson, Brittany Dickson and Hayley Dickson. Our Staff, Mrs. Aitkens and Mrs. Turnbull also took part in this event and donated \$20.00 each for the books they read. Altogether our school succeeded in raising a total of \$257.00 to donate to the Multiple Sclerosis Society of Canada and a total of 81 books were read. We would really like to thank everyone who participated and donated to this cause. Congratulations kids on a job well done and keep reading!!!

❖ Pennies for Patients

- ✦ Also this year for the first time, two boxes were sent to the school to be placed somewhere for the public to donate their pennies to the Leukemia & Lymphoma Society. The boxes were placed in the post office and at Island Grocery. A total of 3,304 pennies were collected.

❖ Jump Rope for Heart

- ✦ This is another annual event that has been going on in our school for many years. The students go door to door to raise money for the Heart & Stroke Foundation and then they have a certain day where they can enjoy skipping all afternoon. They sometimes have contests to see who can skip the longest, learn new skipping techniques or just have fun. Each child receives something for his/her efforts and depending on how much each individual raises they have an opportunity to receive more free stuff. This is a great incentive to get them involved. We would like to take this opportunity to thank Lucas Chenell who helped our school raise funds this year, so thank-you very much Lucas and all the other students. A total of \$389.77 was raised.



❖ Monies Raised for New Playground

- ✦ The students, parents and staff have begun raising money for new playground equipment. Tickets have been sold and we've had a few bingo games and auctions. To date we have raised a total of \$1,985.17. The teachers are sending letters to various companies and the municipality asking for donations as well. They are also looking into the possibility of applying for a grant through the Caisse Populaire and Kino Quebec. So hopefully from the monies received and the help from the Eastern Shores School Board we can raise enough for our dream playground.

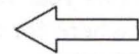
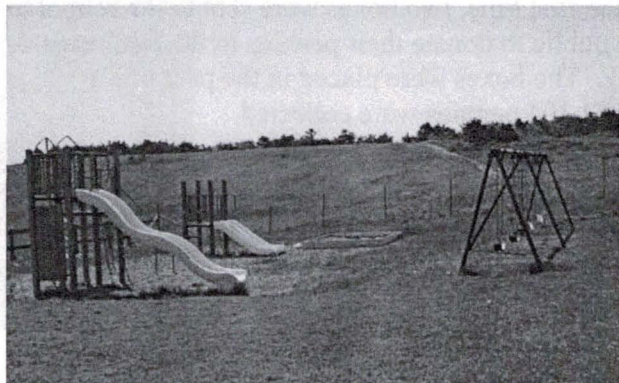

This is the playground we have now, and turn the page to see what we hope to have.....



Our Dream Safe Play ground for
Entry Island School & Municipality
Upgrades for Tougher Environments

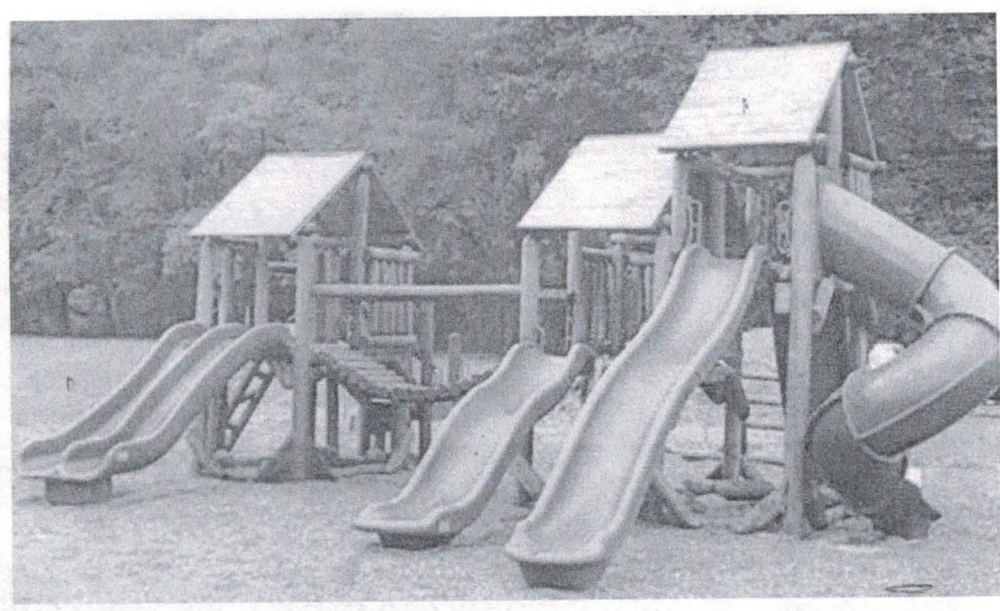
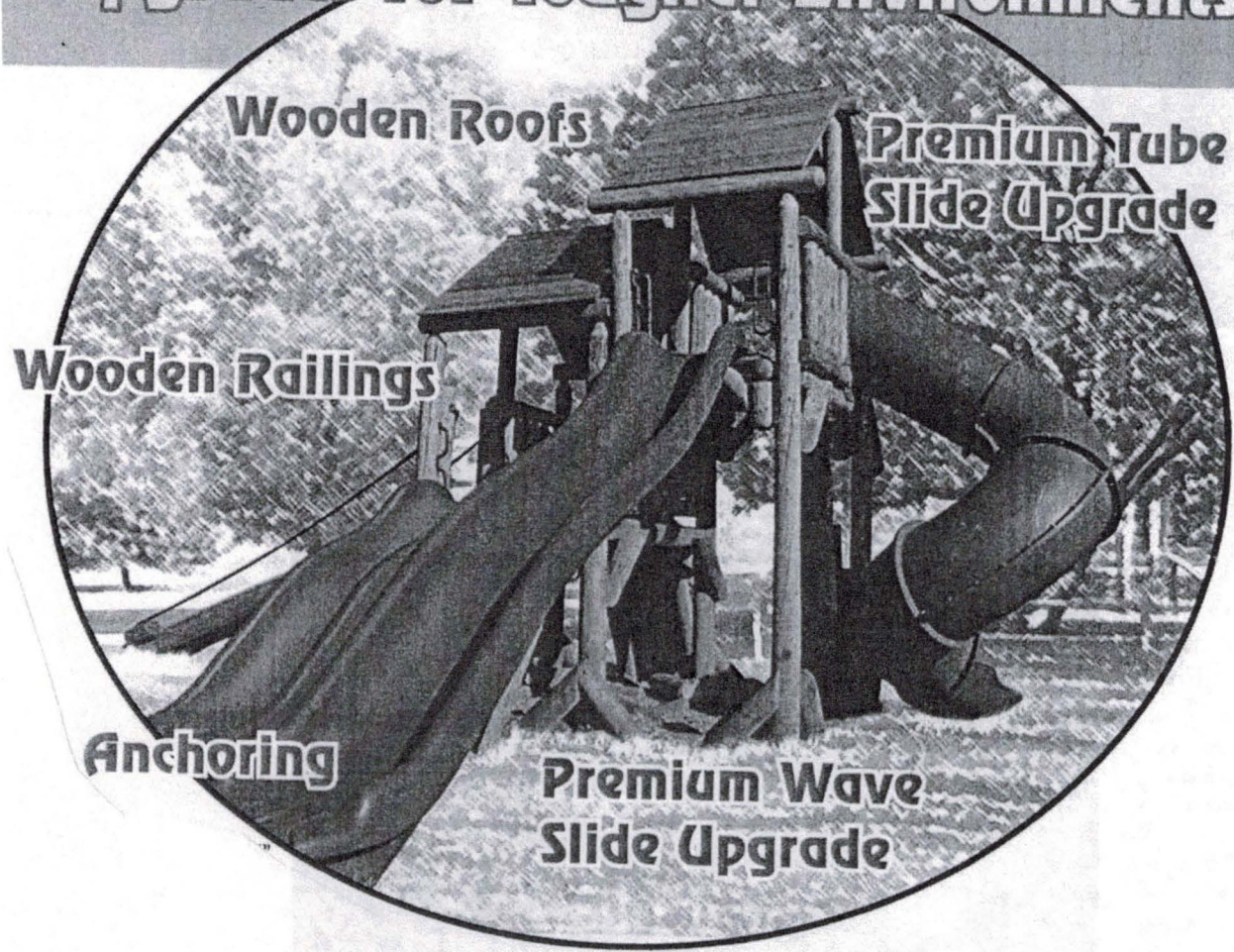

❖ Jump Rope for Heart

- ✦ This is another annual event that has been going on in our school for many years. The students go door to door to raise money for the Heart & Stroke Foundation and then they have a certain day where they can enjoy skipping all afternoon. They sometimes have contests to see who can skip the longest, learn new skipping techniques or just have fun. Each child receives something for his/her efforts and depending on how much each individual raises they have an opportunity to receive more free stuff. This is a great incentive to get them involved. We would like to take this opportunity to thank Lucas Chenell who helped our school raise funds this year, so thank-you very much Lucas and all the other students. A total of \$389.77 was raised.



❖ Monies Raised for New Playground

- ✦ The students, parents and staff have begun raising money for new playground equipment. Tickets have been sold and we've had a few bingo games and auctions. To date we have raised a total of \$1,985.17. The teachers are sending letters to various companies and the municipality asking for donations as well. They are also looking into the possibility of applying for a grant through the Caisse Populaire and Kino Quebec. So hopefully from the monies received and the help from the Eastern Shores School Board we can raise enough for our dream playground.

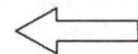
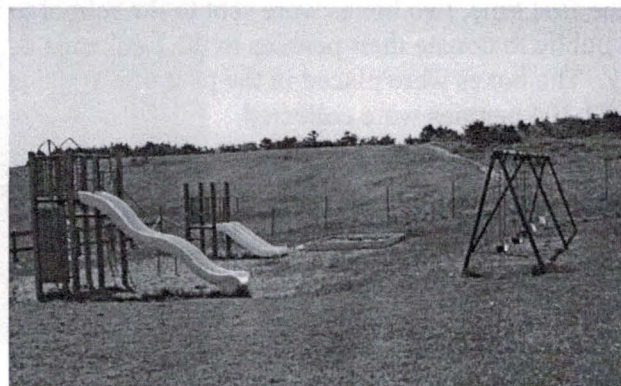

This is the playground we have now, and turn the page to see what we hope to have.....





Never underestimate
the intelligence
of three
young minds! ☺



No
Fools

No
Fun!!!

♥♥ Don't let the
beauty fool you,
these girls are SUPER
intelligent too! ♥♥

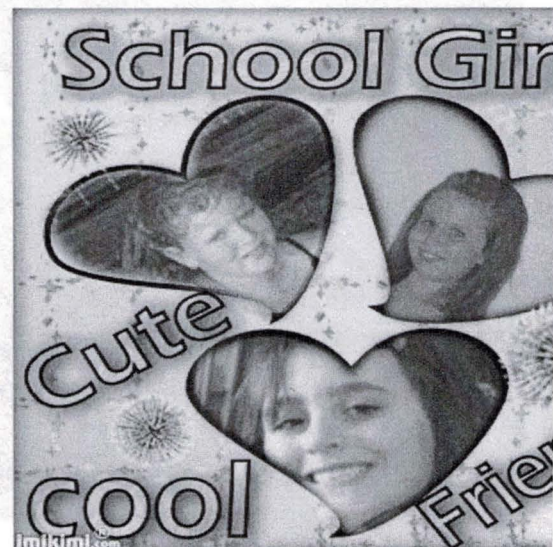

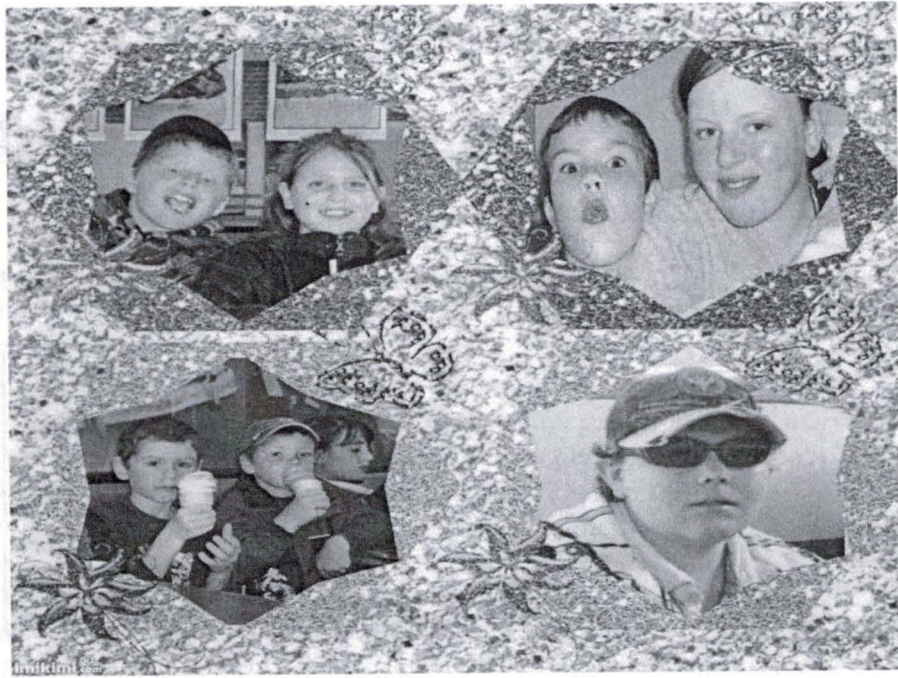

Through the years friendships come & go
But the friends you make as children
Are really the best you know!!



More of our most memorable moments

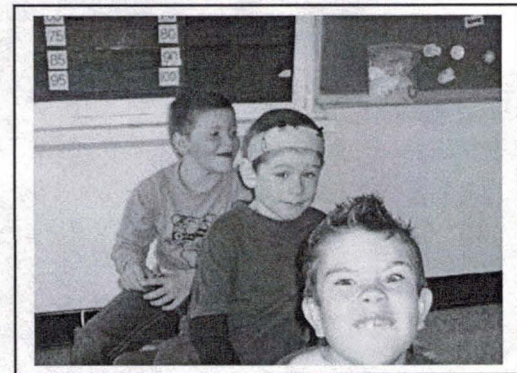
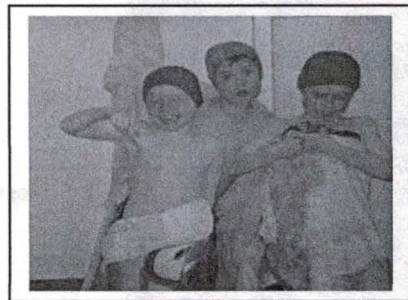
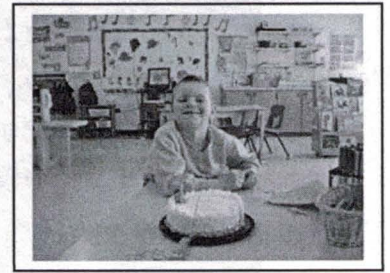

Acknowledgements

First of all, I would like to thank everyone who participated by sending us their recipes or helped in anyway with this 2008-2009 School Yearbook - Community Recipes book.

Next, I really want to thank the editors of this book, Candace Aitkens and her daughter Stacey Dickson, our grade 8 grad, who took their time and created this marvellous book. Thanks Candy and Stacey for all the hard work you put into this yearbook. The staff of Entry Island School really appreciates all you have done for us, otherwise it would have been impossible to have this memory of our year together.

We would also like to give big thanks to my father, Bill Welsh, who voluntarily built the reading loft for the primary classroom, a sandbox and even a picnic table. Thanks dad for giving your daughter, students and great grandchildren something to remember. It means the world to us!!

Judy Aitkens

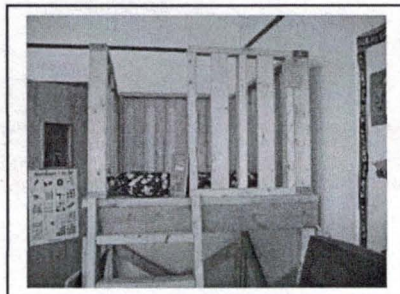
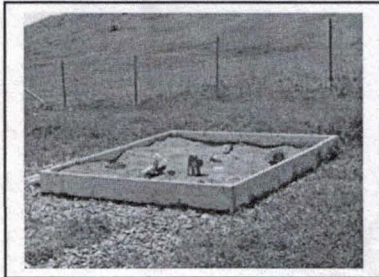

AUTOGRAPHS

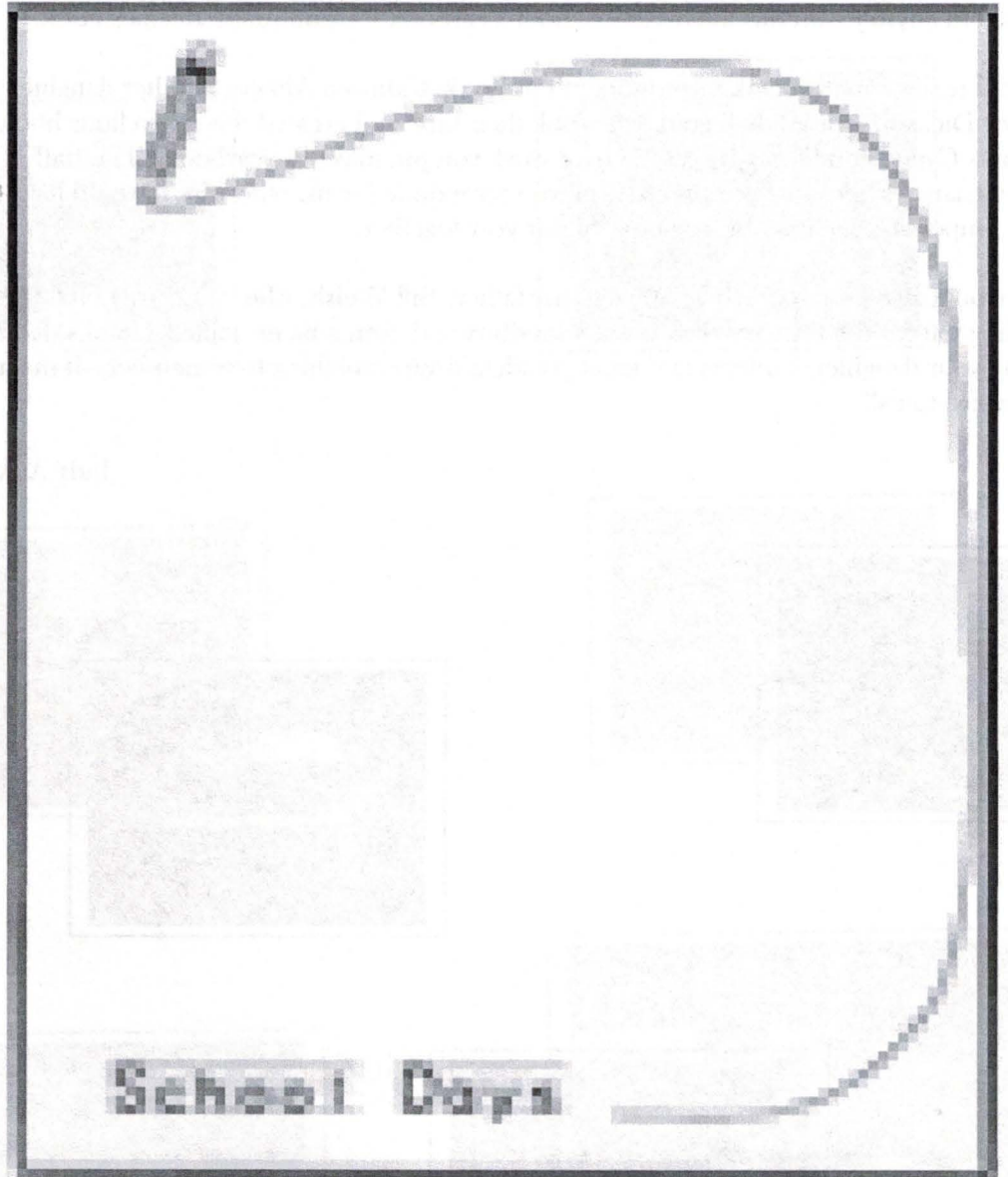

Entry Island School Motto

RESPECT

Rules

Environment

Safety

Playmates

Education

Community

Teachers